

Bravo BUNTING



2012

Bravo fishing

СОДЕРЖАНИЕ / CONTENTS

МОРМЫШКА ВОЛЬФРАМОВАЯ		2	МУРАВЕЙ / КОЗА (кембрик) с гранью и отверстием	№Ч34С	23
WOLFRAM MORMYSHKA			ANT / GOAT (cambrik) w/ werge and aperture		
КАПЛЯ с ушком	№11	2	КАПЛЯ с гранью и отверстием	№35	24
DROP with eyelet			DROP w/ werge and aperture		
КАПЛЯ с отверстием	№12	3	ПОЛУСФЕРА (кембрик, фосфорная заливка) с отверстием	№36С	24
DROP with aperture			HEMISPHERE (cambrik, phosphor filling) with aperture		
МУРАВЕЙ с ушком	№13	4	КАПЛЯ «СПОРТ» (кембрик) с фаской и отверстием	№37С	25
ANT with eyelet			beveled DROP «SPORT» (cambrik) with aperture		
МУРАВЕЙ с отверстием	№14	5	РИСИНКА (кембрик) с отверстием	№39С	25
ANT with aperture			RICE (cambrik) with aperture		
МУРАВЕЙ / КОЗА с отверстием	№К14	6	ЛОДОЧКА с отверстием	№41	26
ANT / GOAT with aperture			BOAT with aperture		
ЧЕШОК / КОЗА с отверстием	№К15	6	НИМФА (безмотылка) с ушком	№45	26
CLOVE / GOAT with aperture			NYMPH (without bait) with eyelet		
ЧЕШОЧНИКА с отверстием	№15	7	ОПАРЫШ с ушком	№42	27
CLOVE with aperture			GRUB with eyelet		
ШАР «ДИСКОТЕКА» с отверстием	№16	8	БАНАН «FOX» с ушком	№46	28
SPHERE «DISCO» with aperture			BANANA «FOX» with eyelet		
ШАР «ДИСКОТЕКА» (кембрик) с отверстием	№16С	8	МУРАВЕЙ (безмотылка) с ушком	№48	28
SPHERE «DISCO» (cambrik) with aperture			ANT (without bait) with eyelet		
ШАР «ДИСКОТЕКА» с ушком	№17	9	МУРАВЕЙ (кембрик, безмотылка) с отверстием	№49С	29
SPHERE «DISCO» with eyelet			ANT (cambrik, without bait) with aperture		
ШАР с отверстием	№19	9	ШАР (кембрик) с гранями и отверстием	№50С	29
SPHERE with aperture			SPHERE (cambrik) w/werge and aperture		
РИЖСКИЙ БАНАН с ушком	№20	10	КАПЛЯ (кембрик, камень) с гранями и отверстием	№51АС	30
RIGA BANANA with eyelet			DROP (cambrik, stone) w/ werge and aperture		
СУПЕРБАНАН с ушком	№18	11	КАПЛЯ (камень) с гранями и ушком	№52А	30
SUPER BANANA with eyelet			DROP (stone) w/ werge and eyelet		
ПЛАВУНЕЦ с ушком	№21	12	КУКОЛКА с ушком	№53	31
WATER-BUG with eyelet			CHRYSALIS with eyelet		
ПЛАВУНЕЦ (глазок) с ушком	№21Е	13	ЧЕРТИК с подвесным тройником	№54Т	31
WATER-BUG (eye) with eyelet			DICKENS with hanging tripple-hook		
РАКУШКА с ушком	№22	14	КИВКИ ЛАВСАНОВЫЕ / LAVSAN NODS		32
SHELL with eyelet			БЛЕСНА ПАЯНАЯ / SOLDERED LURES		45
ЛИЧИНКА с ушком	№23	15	ПЛАНЕР 60	№101	45
MAGGOT with eyelet			GLIDER 60		
МИДИЯ с ушком	№24	16	КРЫЛО	№102	45
MUSSEL with eyelet			WING		
МИДИЯ (камень) с ушком	№24А	17	ДЕЛЬФИН	№103	46
MUSSEL (stone) with eyelet			DOLPHIN		
МОЛОТОК с ушком	№25	18	СНЕТОК	№104	46
MALLET with eyelet			WHITEBAIT		
ШАР (крупная грань) с ушком	№26	18	ТАНЦОР	№108	47
SPHERE (large werge) with eyelet			DANCER		
ШАР с ушком	№28	19	ТОРНАДО	№109	47
SPHERE with eyelet			TORNADO		
УРАЛКА с отверстием	№29	20	ГВОЗДИК	№110	48
URALKA with aperture			NAIL		
ЧЕРТИК с отверстием	№30	21	ЧЕПЛОК	№111	48
DICKENS with aperture			SHUTTLE		
МУРАВЕЙ с гранью и отверстием	№34	21	ЛАХТА	№112	49
ANT w/ werge and aperture			LAKHTA		
ЧЕРТИК (трёхгранный) с кольцом	№32	22	ДЖИГ-ГОЛОВКИ / JIG-HEADS		50
DICKENS (triangular) with ring			УДОЧКИ / WINTER RODS		51
МУРАВЕЙ (кембрик) с гранью и отверстием	№34С	23	АКСЕССУАРЫ / ACESSORIES		52
ANT (cambrik) w/ werge and aperture					

ВОЛЬФРАМОВАЯ МОРМЫШКА

КАПЛЯ с ушком №11 DROP with eyelet

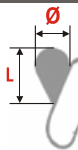

M	1125	1130 _{CF}	1140 _{CF}	1150 _{CF}	1160 _{CF}	1168 _F
Ø	2.5	3.0	4.0	5.0	6.0	6.8
L	3.2	4.3	6.0	7.8	9.0	10.1
W	0.26	0.42	0.99	1.90	2.92	3.80
S	20	18	16	14	12	10



ГАЛЬВАНИКА		GALVANIC		
BN	CU	GO	NI	SIL

ПОКРАСКА			PAINTING		
47	48	49	50	51P _{фосфор phosphor}	52P _{фосфор phosphor}

53	54	55	56	57	58

155	156	157	158	159	160

M	модель model	Ø	диаметр (мм) diameter (mm)	L	длина (мм) length (mm)	W	вес (г) weight (g)	S	номер крючка hook size
----------	-----------------	----------	-------------------------------	----------	---------------------------	----------	-----------------------	----------	---------------------------

Bravo fishing WOLFRAM MORMYSHKA

КАПЛЯ с отверстием №12 DROP with aperture

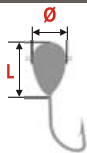

M	1220	1225	1230 ^C	1235 ^{C_F}	1240 ^{C_F}	1245 ^{C_F}	1250 ^{C_F}	1260 ^{C_F}
Ø	2.0	2.5	3.0	3.5	4.0	4.5	5.0	6.0
L	2.9	3.3	4.5	5.1	6.2	7.0	7.8	9.0
W	0.17	0.19	0.37	0.54	0.80	1.25	1.65	2.60
S	20	18	18	16	14	14	12	10

ГАЛЬВАНИКА		GALVANIC		
BN	CU	GO	NI	SIL

ПОКРАСКА			PAINTING		
114	115	116P <small>фосфор phosphor</small>	117	118P <small>фосфор phosphor</small>	119

120	121



C модель с покраской
model with painting

F модель с «мухой»
model with «fly»

ВОЛЬФРАМОВАЯ МОРМЫШКА

МУРАВЕЙ с ушком №13 ANT with eyelet

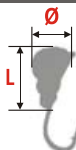

M	1330 <small>C_F</small>	1340 <small>C_F</small>	1350 <small>C_F</small>	1360 <small>C_F</small>
Ø	3.0	4.0	5.0	6.0
L	6.6	8.2	10.2	12.2
W	0.40	0.91	1.71	2.86
S	18	16	14	12



ГАЛЬВАНИКА		GALVANIC		
BN	CU	GO	NI	SIL

ПОКРАСКА		PAINTING			
23	24P <small>фосфор phosphor</small>	25	26	27	28
29	30	31	32	33	34

M	модель model	Ø	диаметр (мм) diameter (mm)	L	длина (мм) length (mm)	W	вес (г) weight (g)	S	номер крючка hook size
----------	-----------------	---	-------------------------------	---	---------------------------	---	-----------------------	---	---------------------------

Bravo fishing WOLFRAM MORMYSHKA

МУРАВЕЙ с отверстием №14 ANT with aperture

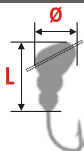

M	1425	1430 ^C	1435	1440 ^C	1450 ^C
Ø	2.5	3.0	3.5	4.0	5.0
L	5.0	6.6	7.2	8.2	10.2
W	0.30	0.52	0.83	1.25	1.85
S	18	16	14	14	12

ГАЛЬВАНИКА		GALVANIC		
BN	CU	GO	NI	SIL

ПОКРАСКА		PAINTING			
23	24P <i>фосфор phosphor</i>	25	26	27	28
29	30	31	32	33	34

C модель с покраской
model with painting

F модель с «мухой»
model with «fly»

ВОЛЬФРАМОВАЯ МОРМЫШКА

МУРАВЕЙ / КОЗА с отверстием

№К14

ANT / GOAT with aperture

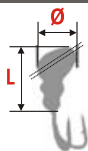

M	K1430	K1435	K1440	K1450
Ø	3.0	3.5	4.0	5.0
L	6.6	7.2	8.2	10.2
W	0.55	0.86	1.30	1.92
S	16	14	14	12

ГАЛЬВАНИКА		GALVANIC		
BN	CU	GO	NI	SIL

ЧЕШОК / КОЗА с отверстием

№К15

CLOVE / GOAT with aperture

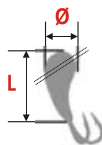

M	K1530	K1535	K1540	K1550
Ø	3.0	3.5	4.0	5.0
L	8.9	9.3	9.8	11.2
W	0.57	0.85	1.18	1.98
S	18	16	14	12

ГАЛЬВАНИКА		GALVANIC		
BN	CU	GO	NI	SIL

M	модель model	Ø	диаметр (мм) diameter (mm)	L	длина (мм) length (mm)	W	вес (г) weight (g)	S	номер крючка hook size
----------	-----------------	----------	-------------------------------	----------	---------------------------	----------	-----------------------	----------	---------------------------

Bravo fishing WOLFRAM MORMYSHKA

ЧЕШОЧНИКА с отверстием

№15

CLOVE with aperture

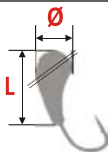

M	1525	1530 ^C	1535 ^C	1540 ^C	1550 ^C
Ø	2.5	3.0	3.5	4.0	5.0
L	8.4	8.9	9.3	9.8	11.2
W	0.35	0.55	0.83	1.15	1.95
S	18	16	14	14	12

ГАЛЬВАНИКА

GALVANIC

BN

CU

GO

NI

SIL



ПОКРАСКА

PAINTING

1

2

3P

фосфор
phosphor

4

5

6



7P

фосфор
phosphor

8

9

10P



C

модель с покраской
model with painting

F

модель с «мухой»
model with «fly»

ВОЛЬФРАМОВАЯ МОРМЫШКА

ШАР «ДИСКОТЕКА» с отверстием

№16

SPHERE «DISCO» with aperture

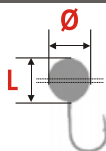

M	1630	1640	1650	1660
Ø	3.0	4.0	5.0	6.0
L	3.0	4.0	5.0	6.0
W	0.23	0.50	1.10	1.90
S	18	16	14	12

ГАЛЬВАНИКА GALVANIC				
BN	CU	GO	NI	SIL

ШАР «ДИСКОТЕКА» (кембрик) с отверстием

№16С

SPHERE «DISCO» (cambric) with aperture

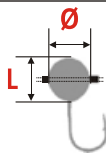

M	1630	1640	1650	1660
Ø	3.0	4.0	5.0	6.0
L	3.0	4.0	5.0	6.0
W	0.23	0.50	1.10	1.90
S	18	16	14	12

ГАЛЬВАНИКА GALVANIC				
BN	CU	GO	NI	SIL

M	модель model	Ø	диаметр (мм) diameter (mm)	L	длина (мм) lenght (mm)	W	вес (г) weight (g)	S	номер крючка hook size
----------	--------------	----------	----------------------------	----------	------------------------	----------	--------------------	----------	------------------------

Bravo fishing WOLFRAM MORMЫШКА

ШАР «ДИСКОТЕКА» с ушком

№17

SPHERE «DISCO» with eyelet

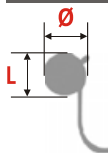

M	1725	1730	1740	1750	1760	1770
Ø	2.5	3.0	4.0	5.0	6.0	7.0
L	2.5	3.0	4.0	5.0	6.0	7.0
W	0.14	0.24	0.58	1.12	1.50	2.00
S	22	20	18	14	12	10

ГАЛЬВАНИКА		GALVANIC		
BN	CU	GO	NI	SIL

ШАР с отверстием

№19

SPHERE with aperture

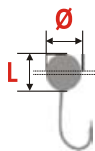

M	1925	1930	1935 ^F	1940 ^F	1945 ^F	1950 ^F	1960 ^F
Ø	2.5	3.0	3.5	4.0	4.5	5.0	6.0
L	2.5	3.0	3.5	4.0	4.5	5.0	6.0
W	0.13	0.24	0.46	0.55	0.80	0.80	1.06
S	18	18	16	16	14	14	12

ГАЛЬВАНИКА		GALVANIC		
BN	CU	GO	NI	SIL

C модель с покраской
model with painting

F модель с «мухой»
model with «fly»

ВОЛЬФРАМОВАЯ МОРМЫШКА

РИЖСКИЙ БАНАН с ушком

№20

RIGA BANANA with eyelet

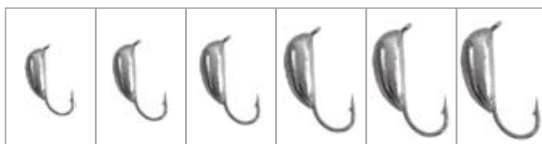
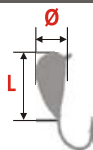

M	2020 ^C	2025 ^C	2030 ^{C_F}	2040 ^{C_F}	2050 ^{C_F}	2060 ^{C_F}
Ø	2.0	2.5	3.0	4.0	5.0	6.0
L	6.8	7.9	8.8	10.5	11.5	12.3
W	0.26	0.37	0.60	1.00	1.50	2.15
S	18	18	16	14	12	10

Внимание!
Для моделей 2020, 2025
и всех "мух" -
покраски только в цвета
от 11 до 21P!

Attention!
For model 2020, 2025
and all "flies"-
paintings only in colors
from 11 till 21P!

ГАЛЬВАНИКА		GALVANIC		
BN	CU	GO	NI	SIL

ПОКРАСКА			PAINTING		
11	12P ^{фосфор} phosphor	13	14	15	16
17	18	19	20P ^{фосфор} phosphor	21P ^{фосфор} phosphor	142
143	144	145	146	147	148

M	модель model	Ø	диаметр (мм) diameter (mm)	L	длина (мм) length (mm)	W	вес (г) weight (g)	S	номер крючка hook size
----------	-----------------	----------	-------------------------------	----------	---------------------------	----------	-----------------------	----------	---------------------------





Bravo fishing WOLFRAM MORMYSHKA

ПОКРАСКА		PAINTING			
149	150	151	152	153	154
					

СУПЕРБАНАН с ушком

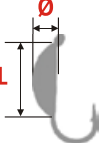
№18

SUPER BANANA with eyelet

				
M	1825 ^C	1830 ^C	1835 ^C	1840 ^C
Ø	2.0	2.2	2.4	2.6
L	8.7	10.5	11.0	11.5
W	0.37	0.54	0.72	0.87
S	16	12	12	12

ГАЛЬВАНИКА		GALVANIC		
BN	CU	GO	NI	SIL
				

ПОКРАСКА		PAINTING			
35	36	37	38	39	40
					
41	42P фосфор phosphor	43	44P фосфор phosphor	45	46
					

C модель с покраской
model with painting

F модель с «мухой»
model with «fly»

ВОЛЬФРАМОВАЯ МОРМЫШКА

ПЛАВУНЕЦ с ушком №21 WATER-BUG with eyelet

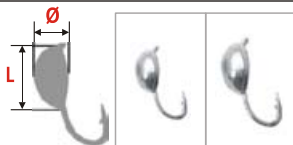

M	2130 ^C	2140 ^C _F
Ø	3.0	4.0
L	5.6	7.2
W	0.50	0.90
S	16	14



ГАЛЬВАНИКА		GALVANIC		
BN	CU	GO	NI	SIL

ПОКРАСКА		PAINTING			
91	92	93	94	95	96
97	98P <small>фосфор phosphor</small>	99	100	101	102

M	модель model	Ø	диаметр (мм) diameter (mm)	L	длина (мм) length (mm)	W	вес (г) weight (g)	S	номер крючка hook size
----------	-----------------	----------	-------------------------------	----------	---------------------------	----------	-----------------------	----------	---------------------------

Bravo fishing WOLFRAM MORMYSHKA

ПЛАВУНЕЦ (глазок) с ушком

№21E

WATER-BUG (eye) with eyelet

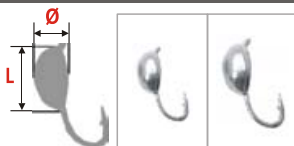

M	2130 ^C	2140 ^C
Ø	3.0	4.0
L	5.6	7.2
W	0.50	0.90
S	16	14

ГАЛЬВАНИКА		GALVANIC		
BN	CU	GO	NI	SIL

ПОКРАСКА			PAINTING		
122	123	124	125	126	127

128	129	130

C модель с покраской
model with painting

F модель с «мухой»
model with «fly»

ВОЛЬФРАМОВАЯ МОРМЫШКА

РАКУШКА с ушком

№22

SHELL with eyelet



M	2230	2240 <small>C F</small>
Ø	3.0	4.0
L	6.1	8.1
W	0.60	1.00
S	16	14



ГАЛЬВАНИКА		GALVANIC		
BN	CU	GO	NI	SIL

ПОКРАСКА			PAINTING		
69	71	73	74P <small>фосфор phosphor</small>	76P <small>фосфор phosphor</small>	77

ПОКРАСКА с 3D глазком			PAINTING with 3D eye		
209	210	211	212	213	214

M	модель model	Ø	диаметр (мм) diameter (mm)	L	длина (мм) length (mm)	W	вес (г) weight (g)	S	номер крючка hook size
----------	-----------------	----------	-------------------------------	----------	---------------------------	----------	-----------------------	----------	---------------------------

Bravo fishing WOLFRAM MORMYSHKA

ЛИЧИНКА с ушком

№23

MAGGOT with eyelet



M	2330 ^C	2340 ^C _F	2350 _F
Ø	3.0	4.0	5.0
L	6.2	7.5	9.3
W	0.50	0.90	1.07
S	16	14	12



Внимание!
"Мухи" -
только с гальваническим
покрытием!

Attention!
"The Flies" -
only with galvanic
coating!

ГАЛЬВАНИКА		GALVANIC		
BN	CU	GO	NI	SIL

ПОКРАСКА		PAINTING			
79	80	81	82	83	84P <small>фосфор phosphor</small>
85	86	87	88	89	90

C модель с покраской
model with painting

F модель с «мухой»
model with «fly»

ВОЛЬФРАМОВАЯ МОРМЫШКА

МИДИЯ с ушком

№24

MUSSEL with eyelet

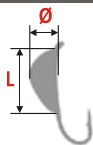

M	2430 ^C	2440 ^C	2450 ^C
Ø	3.0	4.0	5.0
L	6.0	7.0	8.3
W	0.60	1.00	1.30
S	16	14	12

ГАЛЬВАНИКА

GALVANIC

BN	CU	GO	NI	SIL

ПОКРАСКА

PAINTING

59	60	61	62	63P <small>фосфор phosphor</small>	64
65	66	67	68		

M

модель
model

Ø

диаметр (мм)
diameter (mm)

L

длина (мм)
length (mm)

W

вес (г)
weight (g)

S

номер крючка
hook size

Bravo fishing WOLFRAM MORMYSHKA

МИДИЯ (камень) с ушком

№24А

MUSSEL (stone) with eyelet

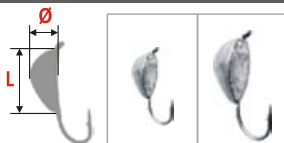

M	2430 ^C	2440 ^C
Ø	3.0	4.0
L	6.3	8.3
W	0.60	1.00
S	16	14

ГАЛЬВАНИКА		GALVANIC		
BN	CU	GO	NI	SIL

ПОКРАСКА		PAINTING		
176	177	178	179	180



C модель с покраской
model with painting

F модель с «мухой»
model with «fly»

ВОЛЬФРАМОВАЯ МОРМЫШКА

МОЛОТОК с ушком №25 MALLET with eyelet



M	2525	2530
Ø	2.5	3.0
L	5.8	7.0
W	0.40	0.65
S	18	16

ГАЛЬВАНИКА		GALVANIC		
BN	CU	GO	NI	SIL

ШАР (крупная грань) с ушком №26 SPHERE (large werge) with eyelet

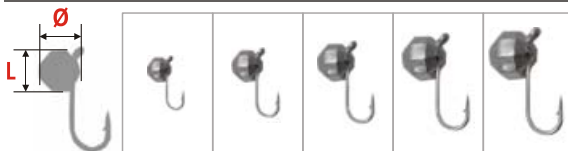

M	2630	2640 _F	2650 _F	2657 _F	2665 _F
Ø	3.0	4.0	5.0	5.7	6.5
L	3.0	4.0	5.0	5.7	6.5
W	0.22	0.52	1.05	1.48	2.30
S	18	16	14	12	10

ГАЛЬВАНИКА		GALVANIC		
BN	CU	GO	NI	SIL

M	модель model	Ø	диаметр (мм) diameter (mm)	L	длина (мм) length (mm)	W	вес (г) weight (g)	S	номер крючка hook size
----------	-----------------	----------	-------------------------------	----------	---------------------------	----------	-----------------------	----------	---------------------------

Bravo fishing WOLFRAM MORMYSHKA

ШАР с ушком

№28

SPHERE with eyelet

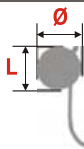

M	2825	2830 ^C	2840 ^{C F}	2850 ^{C F}	2860 ^{C F}	2880	28100	28120
Ø	2.5	3.0	4.0	5.0	6.0	8.0	10.0	12.0
L	2.5	3.0	4.0	5.0	6.0	8.0	10.0	12.0
W	0.18	0.29	0.65	1.20	2.20	4.80	9.39	16.03
S	20	18	16	14	12	10	8	6

ГАЛЬВАНИКА		GALVANIC		
BN	CU	GO	NI	SIL

ПОКРАСКА		PAINTING	
1-BN	1-CU	1-GO	1-SIL

Внимание!
"Мухи" - только с гальваническим покрытием!

Attention!
"The Flies" - only with galvanic coating!



C модель с покраской
model with painting

F модель с «мухой»
model with «fly»

ВОЛЬФРАМОВАЯ МОРМЫШКА

УРАЛКА с отверстием

№29

URALKA with aperture

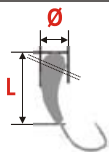

M	2925 ^C	2930 ^C	2940 ^C	2950 ^C
Ø	2.5	3.0	4.0	5.0
L	8.0	10.0	11.2	12.6
W	0.36	0.58	0.98	1.45
S	18	16	14	12

ГАЛЬВАНИКА GALVANIC				
BN	CU	GO	NI	SIL

ПОКРАСКА PAINTING				
7P фосфор phosphor	10P фосфор phosphor	163	164	165



M	модель model	Ø	диаметр (мм) diameter (mm)	L	длина (мм) lenght (mm)	W	вес (г) weight (g)	S	номер крючка hook size
----------	--------------	----------	----------------------------	----------	------------------------	----------	--------------------	----------	------------------------

Bravo fishing WOLFRAM MORMYSHKA

ЧЁРТИК с отверстием

№30

DICKENS with aperture



M	3020	3030	3038	3042
Ø	2.6	2.9	3.8	4.2
L	6.2	8.3	10.2	15.4
W	0.40	0.67	1.02	1.80
S	18	16	14	12

ГАЛЬВАНИКА

GALVANIC

BN

CU

GO

NI

SIL



МУРАВЕЙ с гранью и отверстием

№34

ANT w/ werge and aperture



M	3430	3440	3450
Ø	3.0	4.0	5.0
L	4.5	6.2	7.8
W	0.40	0.90	1.80
S	18	16	14

ГАЛЬВАНИКА

GALVANIC

BN

CU

GO

NI

SIL



C модель с покраской
model with painting

F модель с «мухой»
model with «fly»

ВОЛЬФРАМОВАЯ МОРМЫШКА

ЧЁРТИК (трёхгранный) с кольцом

№32

DICKENS (triangular) with ring

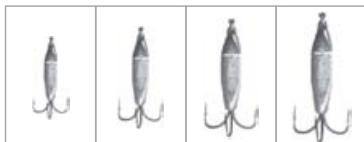
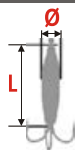

M	3220^C	3230^C	3238^C	3242^C
Ø	2.6	3.2	3.5	4.0
L	9.0	11.0	13.6	16.7
W	0.43	0.70	1.02	1.75
S	18	16	14	12

ГАЛЬВАНИКА		GALVANIC		
BN	CU	GO	NI	SIL

ПОКРАСКА		PAINTING
161	162	175P <small>фосфор phosphor</small>



M	модель model	Ø	диаметр (мм) diameter (mm)	L	длина (мм) length (mm)	W	вес (г) weight (g)	S	номер крючка hook size
----------	-----------------	----------	-------------------------------	----------	---------------------------	----------	-----------------------	----------	---------------------------

Bravo fishing WOLFRAM MORMYSHKA

МУРАВЕЙ (кембрик) с гранью и отверстием

№34С

ANT (cambrik) w/ werge and aperture

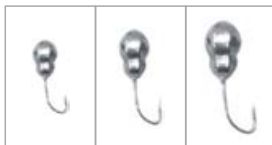
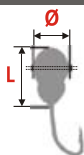

M	3430	3440	3450
Ø	3.0	4.0	5.0
L	4.5	6.2	7.8
W	0.40	0.90	1.80
S	18	16	14

ГАЛЬВАНИКА		GALVANIC		
BN	CU	GO	NI	SIL

МУРАВЕЙ / КОЗА (кембрик) с гранью и отверстием

№K34С

ANT / GOAT (cambrik) w/ werge and aperture

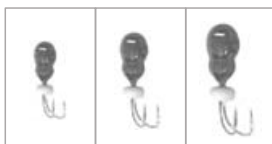
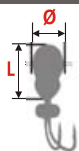

M	K3430С	K3440С	K3450С
Ø	3.0	4.0	5.0
L	4.5	6.2	7.8
W	0.42	0.93	1.85
S	18	16	14

ГАЛЬВАНИКА		GALVANIC		
BN	CU	GO	NI	SIL

C модель с покраской
model with painting

F модель с «мухой»
model with «fly»

ВОЛЬФРАМОВАЯ МОРМЫШКА

КАПЛЯ с гранью и отверстием

№35

DROP w/ verge and aperture

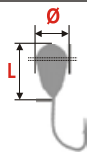

M	3530	3540	3550	3560
Ø	3.0	4.0	5.0	6.0
L	4.5	6.2	7.8	9.0
W	0.35	0.74	1.47	2.60
S	18	16	14	12

ГАЛЬВАНИКА		GALVANIC		
BN	CU	GO	NI	SIL

ПОЛУСФЕРА (кембрик, фосфорная заливка) с отверстием

№36С

HEMISPHERE (cambrik, phosphor filling) with aperture

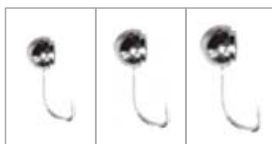
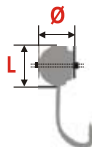

M	3640С	3650С	3660С
Ø	4.0	5.0	6.0
L	4.0	5.0	6.0
W	0.44	0.95	1.80
S	16	14	12

ГАЛЬВАНИКА		GALVANIC		
BN	CU	GO	NI	SIL

M	модель model	Ø	диаметр (мм) diameter (mm)	L	длина (мм) length (mm)	W	вес (г) weight (g)	S	номер крючка hook size
----------	-----------------	----------	-------------------------------	----------	---------------------------	----------	-----------------------	----------	---------------------------

Bravo fishing WOLFRAM MORMЫШКА

КАПЛЯ «СПОРТ» (кембрик) с фаской и отверстием №37С beveled DROP «SPORT» (cambric) with aperture

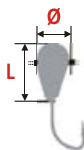

M	3720С	3725С	3730С	3740С	3750С
Ø	2.0	2.5	3.0	4.0	5.0
L	3.0	3.5	4.5	6.2	7.8
W	0.13	0.24	0.45	1.00	1.95
S	20	18	16	14	12

ГАЛЬВАНИКА		GALVANIC		
BN	CU	GO	NI	SIL

РИСИНКА (кембрик) с отверстием №39С RICE (cambric) with aperture

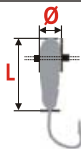

M	3930С	3940С	3950С
Ø	3.0	4.0	5.0
L	7.2	9.5	11.5
W	0.50	1.20	2.00
S	18	16	14

ГАЛЬВАНИКА		GALVANIC		
BN	CU	GO	NI	SIL

C модель с покраской
model with painting

F модель с «мухой»
model with «fly»

ВОЛЬФРАМОВАЯ МОРМЫШКА

ЛОДОЧКА с отверстием №41 BOAT with aperture

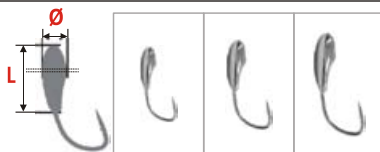

M	4125	4130	4135
Ø	2.5	3.0	3.5
L	5.4	6.5	7.5
W	0.23	0.40	0.61
S	16	14	14

ГАЛЬВАНИКА		GALVANIC		
BN	CU	GO	NI	SIL

НИМФА (безмотылка) с ушком №45 NYMPH (without bait) with eyelet



M	4525^c	4530^c	4540^c
Ø	2.5	3.0	4.0
L	6.0	7.2	9.0
W	0.22	0.47	0.92
S	14	12	10

	215	216
ПОКРАСКА / PAINTING	217	218

ГАЛЬВАНИКА		GALVANIC		
BN	CU	GO	NI	SIL

M	модель model	Ø	диаметр (мм) diameter (mm)	L	длина (мм) length (mm)	W	вес (г) weight (g)	S	номер крючка hook size
----------	-----------------	----------	-------------------------------	----------	---------------------------	----------	-----------------------	----------	---------------------------

Bravo fishing WOLFRAM MORMYSHKA

ОПАРЫШ с ушком

№42

GRUB with eyelet



M	4225	4230 ^C	4240 ^C	4250 ^C
Ø	2.5	3.0	4.0	5.0
L	7.0	7.9	9.2	10.0
W	0.24	0.46	0.71	1.00
S	18	16	14	12

ГАЛЬВАНИКА		GALVANIC		
BN	CU	GO	NI	SIL

ПОКРАСКА		PAINTING			
131	132	133	134	135	135-1

136	137

C модель с покраской
model with painting

F модель с «мухой»
model with «fly»

ВОЛЬФРАМОВАЯ МОРМЫШКА

БАНАН «FOX» с ушком

№46

BANANA «FOX» with eyelet

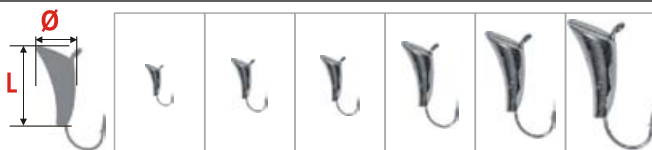

M	4620	4625	4630	4640	4650	4660
Ø	2.0	2.5	3.0	4.0	5.0	6.0
L	4.8	6.2	6.8	10.4	12.9	15.0
W	0.15	0.25	0.35	0.80	1.58	2.76
S	18	18	16	14	12	10

ГАЛЬВАНИКА		GALVANIC		
BN	CU	GO	NI	SIL

МУРАВЕЙ (безмотылка) с ушком

№48

ANT (without bait) with eyelet



M	4830	4835	4840
Ø	3.0	3.5	4.0
L	4.7	6.9	7.0
W	0.29	0.53	0.81
S	16	14	12

ГАЛЬВАНИКА		GALVANIC		
BN	CU	GO	NI	SIL

M	модель model	Ø	диаметр (мм) diameter (mm)	L	длина (мм) length (mm)	W	вес (г) weight (g)	S	номер крючка hook size
----------	-----------------	----------	-------------------------------	----------	---------------------------	----------	-----------------------	----------	---------------------------

Bravo fishing WOLFRAM MORMYSHKA

МУРАВЕЙ (кембрик, безмотылка) с отверстием

№49C

ANT (cambrik, without bait) with aperture

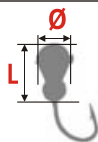

M	4925	4930	4935
Ø	2.5	3.0	3.5
L	4.7	6.0	7.0
W	0.24	0.46	0.71
S	18	16	14

ГАЛЬВАНИКА		GALVANIC		
BN	CU	GO	NI	SIL

ШАР (кембрик) с гранями и отверстием

№50C

SPHERE (cambrik) w/werge and aperture

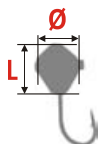

M	5030	5040	5050	5060
Ø	3.0	4.0	5.0	6.0
L	3.0	4.0	5.0	6.0
W	0.19	0.51	0.85	1.40
S	16	14	12	10

ГАЛЬВАНИКА		GALVANIC		
BN	CU	GO	NI	SIL

C модель с покраской
model with painting

F модель с «мухой»
model with «fly»

ВОЛЬФРАМОВАЯ МОРМЫШКА

КАПЛЯ (кембрик, камень) с гранями и отверстием №51AC DROP (cambrik, stone) w/ werge and aperture

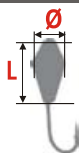

M	5130	5140	5150
Ø	3.0	4.0	5.0
L	5.7	7.5	9.5
W	0.31	0.81	1.80
S	16	14	12

ГАЛЬВАНИКА GALVANIC				
BN	CU	GO	NI	SIL

КАПЛЯ (камень) с гранями и ушком №52A DROP (stone) w/ werge and eyelet



M	5230	5240	5250	5260
Ø	3.0	4.0	5.0	6.0
L	6.0	7.7	9.7	11.5
W	0.37	0.91	1.87	3.18
S	16	14	12	10

ГАЛЬВАНИКА GALVANIC				
BN	CU	GO	NI	SIL

M	модель model	Ø	диаметр (мм) diameter (mm)	L	длина (мм) length (mm)	W	вес (г) weight (g)	S	номер крючка hook size
----------	-----------------	----------	-------------------------------	----------	---------------------------	----------	-----------------------	----------	---------------------------

Bravo fishing WOLFRAM MORMYSHKA

КУКОЛКА с ушком

№53

CHRYSALIS with eyelet

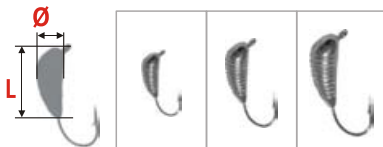

M	5320	5330	5340
Ø	2	3.0	4.0
L	5.5	7.9	9.7
W	0.10	0.44	0.93
S	16	14	12

ГАЛЬВАНИКА		GALVANIC		
BN	CU	GO	NI	SIL

ЧЁРТИК с подвесным тройником

№54Т

DICKENS with hanging tripple-hook

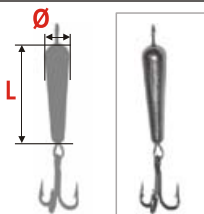

M	5430
Ø	3.0
L	13.5
W	0.85
S	18

ГАЛЬВАНИКА		GALVANIC		
BN	CU	GO	NI	SIL

C модель с покраской
model with painting

F модель с «мухой»
model with «fly»

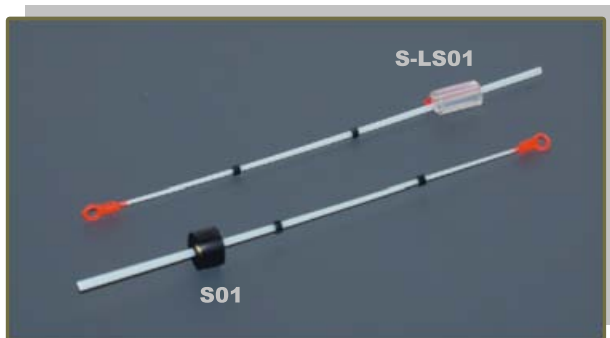

артикул article	жёсткость rigidness	нагрузка (г) load (g)	длина (мм) length (mm)	упаковка (шт.) package (pcs.)
S013511-F25	0,35	0,45 - 1,10	110	25
S015011-F25	0,50	0,60 - 1,40	110	25
S-LS013511-F25	0,35	0,45 - 1,10	110	25
S-LS015011-F25	0,50	0,60 - 1,40	110	25

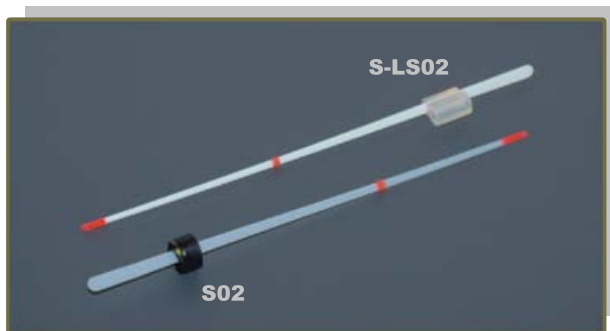

артикул article	жёсткость rigidness	нагрузка (г) load (g)	длина (мм) length (mm)	упаковка (шт.) package (pcs.)
S022012-F25	0,20	0,15 - 0,35	120	25
S022512-F25	0,25	0,25 - 0,35	120	25
S023512-F25	0,35	0,40 - 0,80	120	25
S-LS022012-F25	0,20	0,15 - 0,35	120	25
S-LS022512-F25	0,25	0,25 - 0,50	120	25
S-LS023512-F25	0,35	0,40 - 0,80	120	25

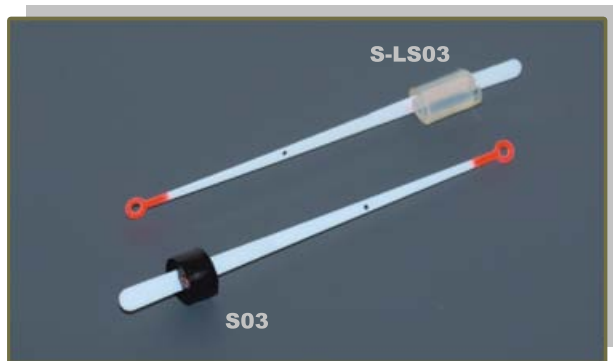

артикул article	жёсткость rigidness	нагрузка (г) load (g)	длина (мм) length (mm)	упаковка (шт.) package (pcs.)
S032008-F25	0,20	0,20 - 0,40	80	25
S032508-F25	0,25	0,25 - 0,60	80	25
S033508-F25	0,35	0,60 - 1,20	80	25
S-LS032008-F25	0,20	0,20 - 0,40	80	25
S-LS032508-F25	0,25	0,25 - 0,60	80	25
S-LS033508-F25	0,35	0,60 - 1,20	80	25

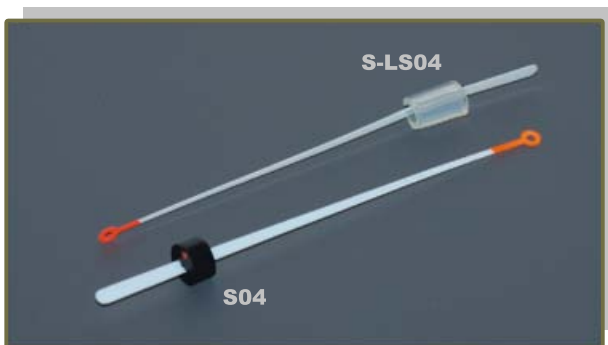

артикул article	жёсткость rigidness	нагрузка (г) load (g)	длина (мм) length (mm)	упаковка (шт.) package (pcs.)
S042010-F25	0,20	0,15 - 0,35	100	25
S042510-F25	0,25	0,25 - 0,50	100	25
S043510-F25	0,35	0,40 - 0,80	100	25
S-LS042010-F25	0,20	0,15 - 0,35	100	25
S-LS042510-F25	0,25	0,25 - 0,50	100	25
S-LS043510-F25	0,35	0,40 - 0,80	100	25



модель с резиновым креплением
model with rubber fixation



модель с силиконовым креплением
model with silicon fixation

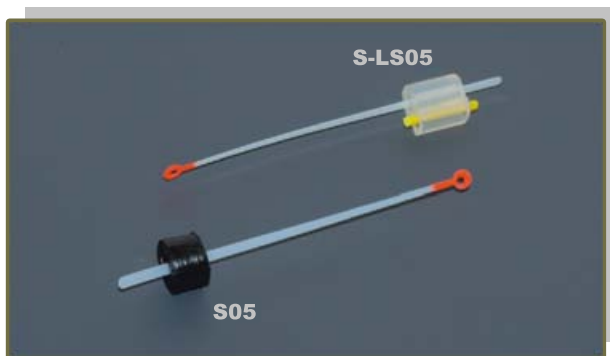

артикул article	жёсткость rigidness	нагрузка (г) load (g)	длина (мм) length (mm)	упаковка (шт.) package (pcs.)
S052008-F25	0,20	0,10 - 0,30	80	25
S052508-F25	0,25	0,20 - 0,40	80	25
S053508-F25	0,35	0,30 - 0,60	80	25
S-LS052008-F25	0,20	0,10 - 0,30	80	25
S-LS052508-F25	0,25	0,20 - 0,40	80	25
S-LS053508-F25	0,35	0,30 - 0,60	80	25

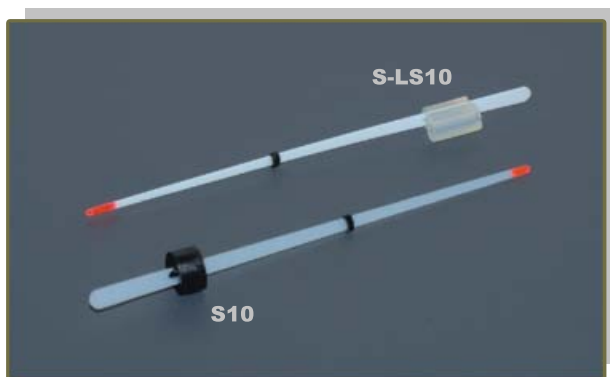

артикул article	жёсткость rigidness	нагрузка (г) load (g)	длина (мм) length (mm)	упаковка (шт.) package (pcs.)
S102010-F25	0,20	0,20 - 0,50	100	25
S102510-F25	0,25	0,25 - 0,55	100	25
S-LS102010-F25	0,20	0,20 - 0,50	100	25
S-LS102510-F25	0,25	0,25 - 0,55	100	25

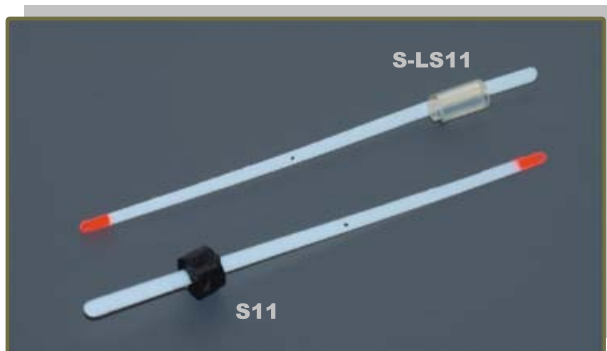

артикул article	жёсткость rigidness	нагрузка (г) load (g)	длинна (мм) length (mm)	упаковка (шт.) package (pcs.)
S112010-F25	0,20	0,15 - 0,35	100	25
S112510-F25	0,25	0,25 - 0,50	100	25
S-LS112010-F25	0,20	0,15 - 0,35	100	25
S-LS112510-F25	0,25	0,25 - 0,50	100	25



артикул article	жёсткость rigidness	нагрузка (г) load (g)	длинна (мм) length (mm)	упаковка (шт.) package (pcs.)
S142014-F25	0,20	0,20 - 0,80	140	25
S142514-F25	0,25	0,30 - 1,20	140	25
S143514-F25	0,35	0,40 - 1,80	140	25
S-LS142014-F25	0,20	0,20 - 0,80	140	25
S-LS142514-F25	0,25	0,30 - 1,20	140	25
S-LS143514-F25	0,35	0,40 - 1,80	140	25



модель с резиновым креплением
model with rubber fixation



модель с силиконовым креплением
model with silicon fixation

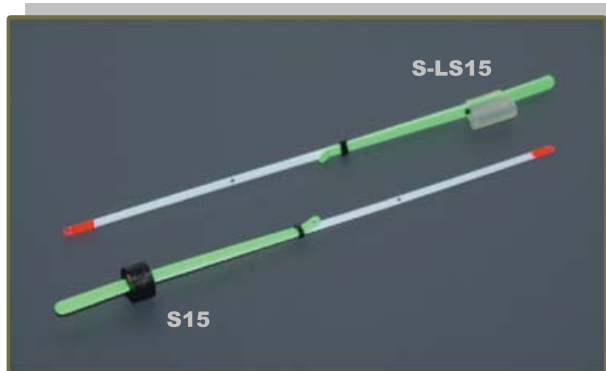

артикул article	жёсткость rigidness	нагрузка (г) load (g)	длина (мм) length (mm)	упаковка (шт.) package (pcs.)
S152012-F25	0,20	0,20 - 0,80	120	25
S152512-F25	0,25	0,30 - 1,20	120	25
S153512-F25	0,35	0,40 - 1,80	120	25
S-LS152012-F25	0,20	0,20 - 0,80	120	25
S-LS152512-F25	0,25	0,30 - 1,20	120	25
S-LS153512-F25	0,35	0,40 - 1,80	120	25



артикул article	жёсткость rigidness	нагрузка (г) load (g)	длина (мм) length (mm)	упаковка (шт.) package (pcs.)
S162012-F25	0,20	0,20 - 0,80	120	25
S162512-F25	0,25	0,30 - 1,20	120	25
S163512-F25	0,35	0,40 - 1,80	120	25
S-LS162012-F25	0,20	0,20 - 0,80	120	25
S-LS162512-F25	0,25	0,30 - 1,20	120	25
S-LS163512-F25	0,35	0,40 - 1,80	120	25

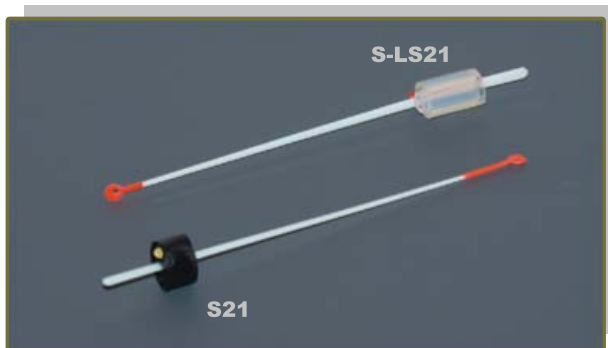

артикул article	жёсткость rigidness	нагрузка (г) load (g)	длинна (мм) length (mm)	упаковка (шт.) package (pcs.)
S212008-F25	0,20	0,10 - 0,25	80	25
S212508-F25	0,25	0,15 - 0,35	80	25
S213508-F25	0,35	0,30 - 0,60	80	25
S-LS212008-F25	0,20	0,10 - 0,25	80	25
S-LS212508-F25	0,25	0,15 - 0,35	80	25
S-LS213508-F25	0,35	0,30 - 0,60	80	25



артикул article	жёсткость rigidness	нагрузка (г) load (g)	длинна (мм) length (mm)	упаковка (шт.) package (pcs.)
S312008-F25	0,20	0,15 - 0,35	80	25
S312508-F25	0,25	0,20 - 0,45	80	25
S313508-F25	0,35	0,45 - 0,90	80	25
S-LS312008-F25	0,20	0,15 - 0,35	80	25
S-LS312508-F25	0,25	0,20 - 0,45	80	25
S-LS313508-F25	0,35	0,45 - 0,90	80	25



модель с резиновым креплением
model with rubber fixation



модель с силиконовым креплением
model with silicon fixation

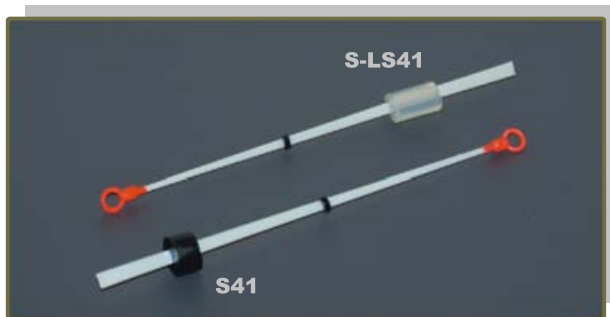

артикул article	жёсткость rigidness	нагрузка (г) load (g)	длина (мм) length (mm)	упаковка (шт.) package (pcs.)
S412010-F25	0,20	0,15 - 0,25	100	25
S412510-F25	0,25	0,20 - 0,30	100	25
S413510-F25	0,35	0,40 - 0,80	100	25
S415010-F25	0,50	0,70 - 1,50	100	25
S-LS412010-F25	0,20	0,15 - 0,25	100	25
S-LS412510-F25	0,25	0,20 - 0,30	100	25
S-LS413510-F25	0,35	0,40 - 0,80	100	25
S-LS415010-F25	0,50	0,70 - 1,50	100	25

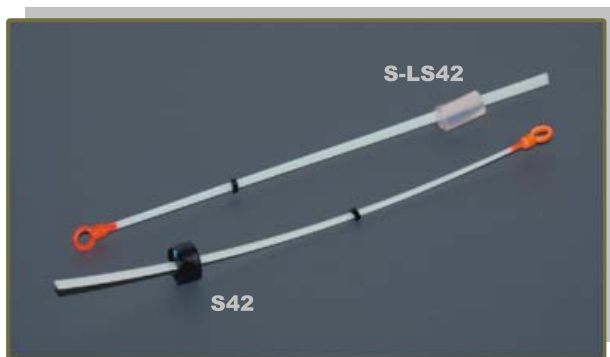

артикул article	жёсткость rigidness	нагрузка (г) load (g)	длина (мм) length (mm)	упаковка (шт.) package (pcs.)
S422512-F25	0,25	0,20 - 0,40	120	25
S423512-F25	0,35	0,40 - 0,80	120	25
S425012-F25	0,50	0,70 - 1,60	120	25
S-LS422512-F25	0,25	0,20 - 0,40	120	25
S-LS423512-F25	0,35	0,40 - 0,80	120	25
S-LS425012-F25	0,50	0,70 - 1,60	120	25

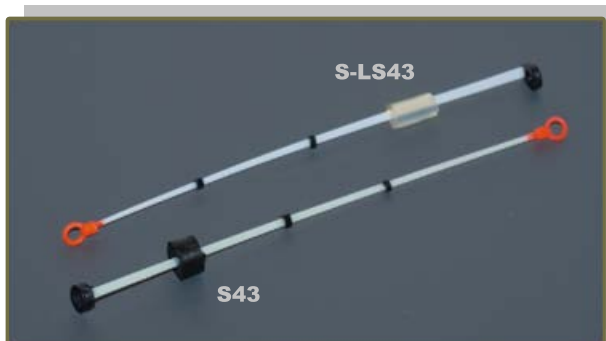

артикул article	жёсткость rigidness	нагрузка (г) load (g)	длина (мм) length (mm)	упаковка (шт.) package (pcs.)
S432512-F25	0,25	0,20 - 0,40	120	25
S433512-F25	0,35	0,40 - 0,80	120	25
S435012-F25	0,50	0,70 - 1,60	120	25
S-LS432512-F25	0,25	0,20 - 0,40	120	25
S-LS433512-F25	0,35	0,40 - 0,80	120	25
S-LS435012-F25	0,50	0,70 - 1,60	120	25



артикул article	жёсткость rigidness	нагрузка (г) load (g)	длина (мм) length (mm)	упаковка (шт.) package (pcs.)
S512516-F25	0,25	0,15 - 0,45	160	25
S513516-F25	0,35	0,35 - 0,75	160	25
S-LS512516-F25	0,25	0,15 - 0,45	160	25
S-LS513516-F25	0,35	0,35 - 0,75	160	25



модель с резиновым креплением
model with rubber fixation



модель с силиконовым креплением
model with silicon fixation



артикул article	жѣсткость rigidness	нагрузка (г) load (g)	длина (мм) length (mm)	упаковка (шт.) package (pcs.)
S522516-F25	0,25	0,15 - 0,45	160	25
S523516-F25	0,35	0,35 - 0,75	160	25
S-LS522516-F25	0,25	0,15 - 0,45	160	25
S-LS523516-F25	0,35	0,35 - 0,75	160	25



артикул article	жѣсткость rigidness	нагрузка (г) load (g)	длина (мм) length (mm)	упаковка (шт.) package (pcs.)
S612010-F25	0,20	0,15 - 0,35	100	25
S612510-F25	0,25	0,30 - 0,70	100	25
S613510-F25	0,35	0,50 - 1,00	100	25
S-LS612010-F25	0,20	0,15 - 0,35	100	25
S-LS612510-F25	0,25	0,30 - 0,70	100	25
S-LS613510-F25	0,35	0,50 - 1,00	100	25



артикул article	жёсткость rigidness	нагрузка (г) load (g)	длинна (мм) length (mm)	упаковка (шт.) package (pcs.)
S713516-F25	0,35	0,50 - 1,00	160	25
S715016-F25	0,50	0,70 - 1,40	160	25
S-LS713516-F25	0,35	0,50 - 1,00	160	25
S-LS715016-F25	0,50	0,70 - 1,40	160	25



артикул article	жёсткость rigidness	нагрузка (г) load (g)	длинна (мм) length (mm)	упаковка (шт.) package (pcs.)
S723518-F25	0,35	0,40 - 0,80	180	25
S725018-F25	0,50	0,50 - 1,50	180	25
S-LS723518-F25	0,35	0,40 - 0,80	180	25
S-LS725018-F25	0,50	0,50 - 1,50	180	25



модель с резиновым креплением
model with rubber fixation



модель с силиконовым креплением
model with silicon fixation



артикул article	жёсткость rigidness	нагрузка (г) load (g)	длина (мм) length (mm)	упаковка (шт.) package (pcs.)
S733518-F25	0,35	0,40 - 0,80	180	25
S735018-F25	0,50	0,50 - 1,50	180	25
S-LS733518-F25	0,35	0,40 - 0,80	180	25
S-LS735018-F25	0,50	0,50 - 1,50	180	25

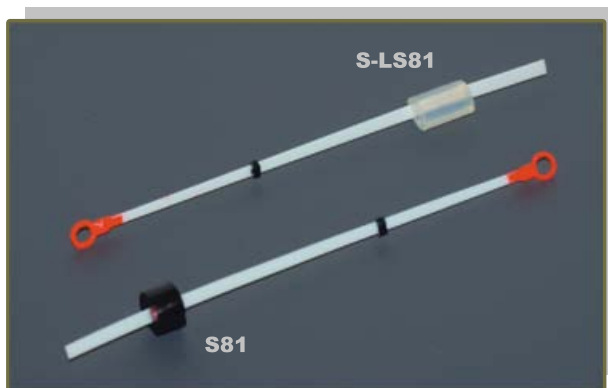

артикул article	жёсткость rigidness	нагрузка (г) load (g)	длина (мм) length (mm)	упаковка (шт.) package (pcs.)
S812510-F25	0,25	0,15 - 0,45	100	25
S813510-F25	0,35	0,35 - 0,70	100	25
S815010-F25	0,50	0,70 - 1,40	100	25
S-LS812510-F25	0,25	0,15 - 0,45	100	25
S-LS813510-F25	0,35	0,35 - 0,70	100	25
S-LS815010-F25	0,50	0,70 - 1,40	100	25



артикул article	жёсткость rigidness	нагрузка (г) load (g)	длина (мм) length (mm)	упаковка (шт.) package (pcs.)
S912508-F25	0,25	0,30 - 0,60	80	25
S913508-F25	0,35	0,50 - 0,80	80	25
S-LS912508-F25	0,25	0,30 - 0,60	80	25
S-LS913508-F25	0,35	0,50 - 0,80	80	25

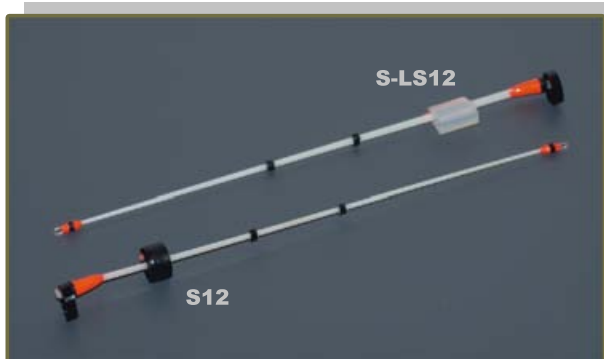

артикул article	жёсткость rigidness	нагрузка (г) load (g)	длина (мм) length (mm)	упаковка (шт.) package (pcs.)
S122508-F25	0,25	0,25 - 0,55	80	25
S122512-F25	0,25	0,20 - 0,50	120	25
S123508-F25	0,35	0,40 - 0,80	80	25
S123512-F25	0,35	0,30 - 0,70	120	25
S123515-F25	0,35	0,25 - 0,80	150	25
S125012-F25	0,50	0,60 - 1,60	120	25
S125015-F25	0,50	0,45 - 1,50	150	25
S-LS122508-F25	0,25	0,25 - 0,55	80	25
S-LS122512-F25	0,25	0,20 - 0,50	120	25
S-LS123508-F25	0,35	0,40 - 0,80	80	25
S-LS123512-F25	0,35	0,30 - 0,70	120	25
S-LS123515-F25	0,35	0,25 - 0,80	150	25
S-LS125012-F25	0,50	0,60 - 1,60	120	25
S-LS125015-F25	0,50	0,45 - 1,50	150	25



модель с резиновым креплением
model with rubber fixation



модель с силиконовым креплением
model with silicon fixation

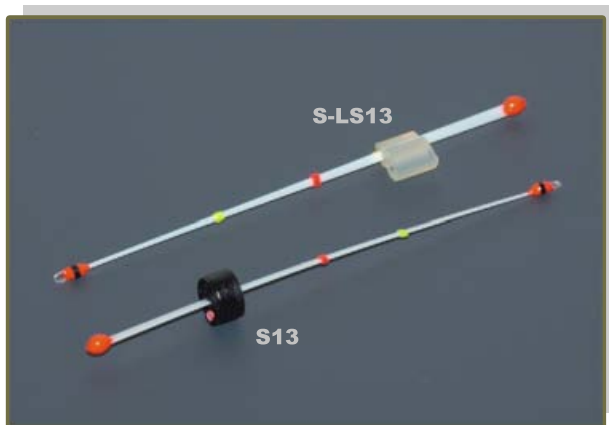

артикул article	жёсткость rigidness	нагрузка (г) load (g)	длина (мм) length (mm)	упаковка (шт.) package (pcs.)
S132006-F25	0,20	0,20 - 0,40	60	25
S132008-F25	0,20	0,20 - 0,30	80	25
S132010-F25	0,20	0,15 - 0,40	100	25
S132507-F25	0,25	0,30 - 0,60	70	25
S133509-F25	0,35	0,50 - 1,00	90	25
S-LS132006-F25	0,20	0,20 - 0,40	60	25
S-LS132008-F25	0,20	0,20 - 0,30	80	25
S-LS132010-F25	0,20	0,15 - 0,40	100	25
S-LS132507-F25	0,25	0,30 - 0,60	70	25
S-LS133509-F25	0,35	0,50 - 1,00	90	25



ПЛАНЕР 60 №101 GLIDER 60

артикул article	длина (мм) length (mm)	вес (г) weight (g)	цвет colour	оснастка equipment
WL-101-1-CU-SIL	60	10.0	CU/SIL	цепочка с одним крючком / chain with single hook
WL-101-1-GO-SIL	60	10.0	GO/SIL	цепочка с одним крючком / chain with single hook
WL-101-1-GO-CU	60	10.0	GO/CU	цепочка с одним крючком / chain with single hook
WL-101-3H-CU-SIL	60	10.0	CU/SIL	с тройником / with tripple hook
WL-101-3H-GO-SIL	60	10.0	GO/SIL	с тройником / with tripple hook
WL-101-3H-GO-CU	60	10.0	GO/CU	с тройником / with tripple hook
WL-101-3-CU-SIL	60	10.0	CU/SIL	цепочка с тройником / chain with tripple hook
WL-101-3-GO-SIL	60	10.0	GO/SIL	цепочка с тройником / chain with tripple hook
WL-101-3-GO-CU	60	10.0	GO/CU	цепочка с тройником / chain with tripple hook



КРЫЛО №102 WING

артикул article	длина (мм) length (mm)	вес (г) weight (g)	цвет colour	оснастка equipment
WL-102-1-1-CU-SIL	50	10.0	CU/SIL	цепочка с одним крючком / chain with single hook
WL-102-1-1-GO-SIL	50	10.0	GO/SIL	цепочка с одним крючком / chain with single hook
WL-102-1-1-GO-CU	50	10.0	GO/CU	цепочка с одним крючком / chain with single hook
WL-102-1-2-CU-SIL	64	10.0	CU/SIL	цепочка с одним крючком / chain with single hook
WL-102-1-2-GO-SIL	64	10.0	GO/SIL	цепочка с одним крючком / chain with single hook
WL-102-1-2-GO-CU	64	10.0	GO/CU	цепочка с одним крючком / chain with single hook
WL-102-3H-CU-SIL	64	10.0	CU/SIL	с тройником / with tripple hook
WL-102-3H-GO-SIL	64	10.0	GO/SIL	с тройником / with tripple hook
WL-102-3H-GO-CU	64	10.0	GO/CU	с тройником / with tripple hook
WL-102-3-1-CU-SIL	50	10.0	CU/SIL	цепочка с тройником / chain with tripple hook
WL-102-3-1-GO-SIL	50	10.0	GO/SIL	цепочка с тройником / chain with tripple hook
WL-102-3-1-GO-CU	50	10.0	GO/CU	цепочка с тройником / chain with tripple hook
WL-102-3-2-CU-SIL	64	10.0	CU/SIL	цепочка с тройником / chain with tripple hook
WL-102-3-2-GO-SIL	64	10.0	GO/SIL	цепочка с тройником / chain with tripple hook
WL-102-3-2-GO-CU	64	10.0	GO/CU	цепочка с тройником / chain with tripple hook



цепочка с одним крючком
chain with single hook

с тройником
with tripple hook

ДЕЛЬФИН №103 DOLPHIN

артикул article	длина (мм) length (mm)	вес (г) weight (g)	цвет colour	оснастка equipment
WL-103-1-1-CU-SIL	60	27.0	CU/SIL	крючок впаянный / with solded hook
WL-103-1-1-GO-SIL	60	27.0	GO/SIL	крючок впаянный / with solded hook
WL-103-1-2-CU-SIL	75	CU/SIL	крючок впаянный / with solded hook	
WL-103-1-2-GO-SIL	75	38.0	GO/SIL	крючок впаянный / with solded hook
WL-103-3-1-CU-SIL	60	27.0	CU/SIL	с тройником / with tripple hook
WL-103-3-1-GO-SIL	60	27.0	GO/SIL	с тройником / with tripple hook
WL-103-3-2-CU-SIL	75	38.0	CU/SIL	с тройником / with tripple hook
WL-103-3-2-GO-SIL	75	38.0	GO/SIL	с тройником / with tripple hook



СНЕТОК №104 WHITEBAIT

артикул article	длина (мм) length (mm)	вес (г) weight (g)	цвет colour	оснастка equipment
WL-104-1-2-CU-SIL	62	10.5	CU/SIL	цепочка с одним крючком / chain with single hook
WL-104-1-2-GO-SIL	62	10.5	GO/SIL	цепочка с одним крючком / chain with single hook
WL-104-1-2-GO-CU	62	10.5	GO/CU	цепочка с одним крючком / chain with single hook
WL-104-3-1-CU-SIL	45	7.0	CU/SIL	с тройником / with tripple hook
WL-104-3-1-GO-SIL	45	7.0	GO/SIL	с тройником / with tripple hook
WL-104-3-1-GO-CU	45	7.0	GO/CU	с тройником / with tripple hook
WL-104-3-2-CU-SIL	62	10.5	CU/SIL	цепочка с тройником / chain with tripple hook
WL-104-3-2-GO-SIL	62	10.5	GO/SIL	цепочка с тройником / chain with tripple hook
WL-104-3-2-GO-CU	62	10.5	GO/CU	цепочка с тройником / chain with tripple hook



ТАНЦОР №108 DANCER

артикул article	длина (мм) length (mm)	вес (г) weight (g)	цвет colour	оснастка equipment
WL-108-3S-1-CU-SIL	54	13.5	CU/SIL	с тройником / with tripple hook
WL-108-3S-1-GO-SIL	54	13.5	GO/SIL	с тройником / with tripple hook
WL-108-3S-1-GO-CU	54	13.5	GO/CU	с тройником / with tripple hook
WL-108-3S-2-CU-SIL	45	12.8	CU/SIL	с тройником / with tripple hook
WL-108-3S-2-GO-SIL	45	12.8	GO/SIL	с тройником / with tripple hook
WL-108-3S-2-GO-CU	45	12.8	GO/CU	с тройником / with tripple hook
WL-108-3S-3-CU-SIL	40	9.0	CU/SIL	с тройником / with tripple hook
WL-108-3S-3-GO-SIL	40	9.0	GO/SIL	с тройником / with tripple hook
WL-108-3S-3-GO-CU	40	9.0	GO/CU	с тройником / with tripple hook
WL-108-3S-4-CU-SIL	36	7.0	CU/SIL	с тройником / with tripple hook
WL-108-3S-4-GO-SIL	36	7.0	GO/SIL	с тройником / with tripple hook
WL-108-3S-4-GO-CU	36	7.0	GO/CU	с тройником / with tripple hook



ТОРНАДО №109 TORNADO

артикул article	длина (мм) length (mm)	вес (г) weight (g)	цвет colour	оснастка equipment
WL-109-3-CU-SIL	45	12.5	CU/SIL	с тройником / with tripple hook
WL-109-3-GO-SIL	45	12.5	GO/SIL	с тройником / with tripple hook
WL-109-3-GO-CU	45	12.5	GO/CU	с тройником / with tripple hook



цепочка с одним крючком
chain with single hook

с тройником
with tripple hook

ГВОЗДИК №110 NAIL

артикул article	длина (мм) length (mm)	вес (г) weight (g)	цвет colour	оснастка equipment
WL-110-CU-SIL	40	4.0	CU/SIL	цепочка с тройником / chain with tripple hook
WL-110-GO-SIL	40	4.0	GO/SIL	цепочка с тройником / chain with tripple hook
WL-110-GO-CU	40	4.0	GO/CU	цепочка с тройником / chain with tripple hook



ЧЕЛНОК №111 SHUTTLE

артикул article	длина (мм) length (mm)	вес (г) weight (g)	цвет colour	оснастка equipment
WL-111-CU-SIL	40	3.5	CU/SIL	цепочка с тройником / chain with tripple hook
WL-111-GO-SIL	40	3.5	GO/SIL	цепочка с тройником / chain with tripple hook
WL-111-GO-CU	40	3.5	GO/CU	цепочка с тройником / chain with tripple hook



ЛАХТА №112 ЛАХТА

артикул article	длина (мм) length (mm)	вес (г) weight (g)	цвет colour	оснастка equipment
WL-112-CU-SIL	40	6.5	CU/SIL	цепочка с тройником / chain with tripple hook
WL-112-GO-SIL	40	6.5	GO/SIL	цепочка с тройником / chain with tripple hook
WL-112-GO-CU	40	6.5	GO/CU	цепочка с тройником / chain with tripple hook



 цепочка с одним крючком
chain with single hook

 с тройником
with tripple hook

МИКРОДЖИГ №43 MICRO JIG

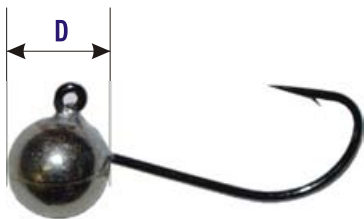

артикул article	диам. (мм) diam. (mm)	вес (г) weight (g)	цвет colour	крючок hook
4320	6,0	2.00	NI	№6
4330	6,9	3.00	NI	№6
4340	7,6	4.00	NI	№4
4350	8,2	5.00	NI	№4
4360	8,7	6.00	NI	№4
4370	9,2	7.00	NI	№2
4380	9,6	8.00	NI	№1

ЧЕБУРАШКА с ушком №43У СNEBURASHKA with eyelet



артикул article	диам. (мм) diam. (mm)	вес (г) weight (g)	цвет colour
4320У	6,0	2.00	NI
4330У	6.9	3.00	NI
4340У	7.6	4.00	NI
4350У	8.2	5.00	NI
4360У	8.7	6.00	NI
4370У	9.2	7.00	NI
4380У	9.6	8.00	NI

ЧЕБУРАШКА с замком №44 СNEBURASHKA with clasp



артикул article	диам. (мм) diam. (mm)	вес (г) weight (g)	цвет colour
4410	4.9	1.00	NI
4420	6.0	2.00	NI
4430	6.9	3.00	NI
4440	7.6	4.00	NI
4450	8.2	5.00	NI
4460	8.7	6.00	NI
4480	9.6	8.00	NI

ЗИМНИЕ УДОЧКИ

WINTER RODS



ST-1K-C*

Удочка оснащена контейнером под шпулю, который при перепаде температур не даёт усадку мягкому материалу из которого сделан корпус - по-этому шпуля неподклинивается.

Rod is equipped with a container under the spool, which at difference of temperatures gives no shrinkage of the soft material from which made hull - the spool will not stuck.

цвета C* colors



цвета C* colors

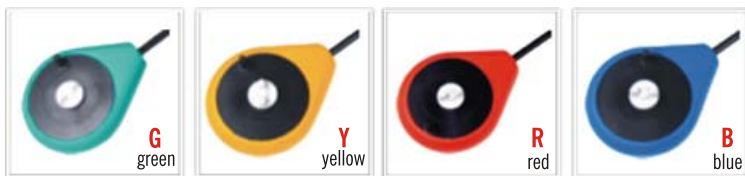

BAL-C*

МОРМЫШКА «МАГИЯ» на цепочке с застёжкой / MORMYSHKA «MAGIC» with chain and clasp



артикул article	крючок № hook size	длина цепочки (мм) chain length (mm)	застёжка № clasp size
MAGC-12-2	12	20	3
MAGC-10-3	10	30	3

ЦЕПОЧКА с застёжками / CHAIN with clasps



артикул article	длина цепочки (мм) chain length (mm)	застёжка № clasp size
CZM-2-3-15	15	2*3
CZM-2-3-20	20	2*3
CZM-2-3-25	25	2*3
CZM-2-3-30	30	2*3
CZM-2-3-35	35	2*3

ТРОЙНИК MUSTAD с эпоксидом / TRIPPLE-HOOK MUSTAD with epoxide



артикул article	крючок № hook size
TRMS-8	8
TRMS-10	10
TRMS-12	12
TRMS-14	14
TRMS-16	16

ТРОЙНИК OWNER с трёхцветной каплей и 3D глазком / TRIPPLE-HOOK OWNER with three-color drop and 3D eye



артикул article	крючок № hook size
TROW-12	12
TROW-14	14
TROW-16	16
TROW-18	18

Контакты:

Адрес: ул. Маскавас 322а, Рига LV-1063, Латвия
Телефон (моб.): +371 29 10 22 45
Телефон/факс: +371 67 14 02 85
Э-почта: info@bravofishing.ru
www.bravofishing.ru

Contacts:

Address: Maskavas street 322a, Riga LV-1063, Latvia
Phone: +371 29 10 22 45
Phone/Fax: +371 67 14 02 85
E-mail: info@bravofishing.ru
www.bravofishing.ru

